

GL-H28 行動電話型針孔祕錄蒐證器

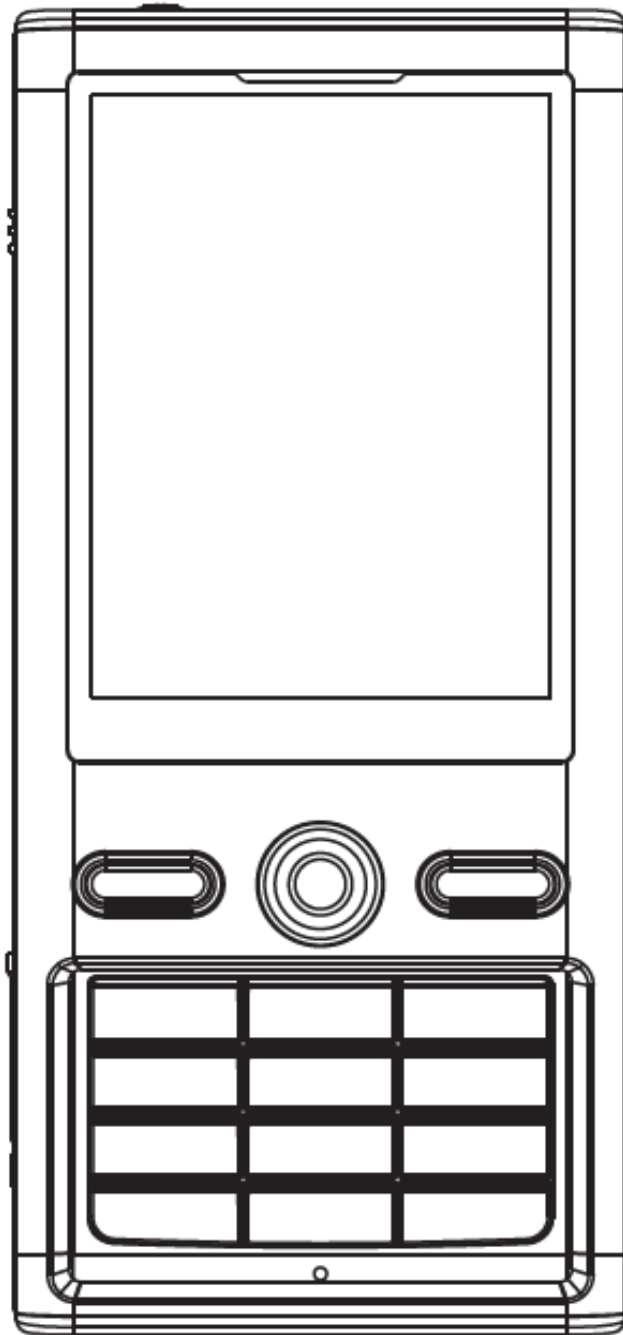

GREENLEAF ENTERPRISE

Professional SPY Products Manufacturer

● 部件名稱

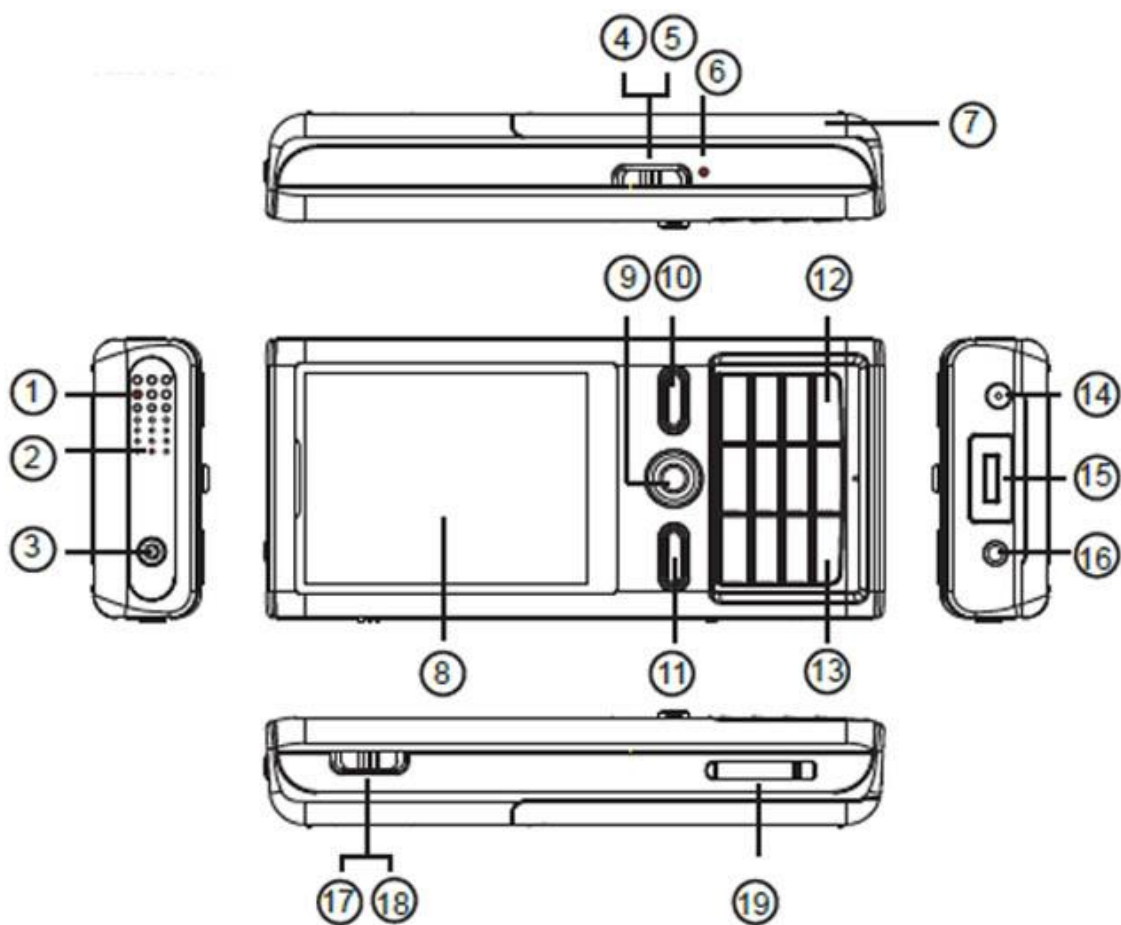

1.數位鏡頭攝影機	11.取消鍵 ESC
2.收音麥克風	12.音量(大)
3.電源開關	13.音量(小)
4.震動提示(開)	14.充電連接埠
5.震動提示(關)	15.專用 USB 埠
6.復歸鍵 Reset	16.外接攝影機埠
7.電池背蓋	17.錄影(停止)•待機
8. 2.5" LCD	18.錄影(開始)
9.方向選擇確認鍵	19. Micro SD 插槽
10.目錄鍵	

●配件

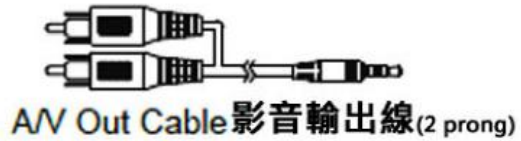
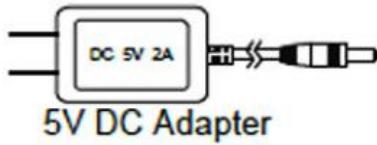

●充電

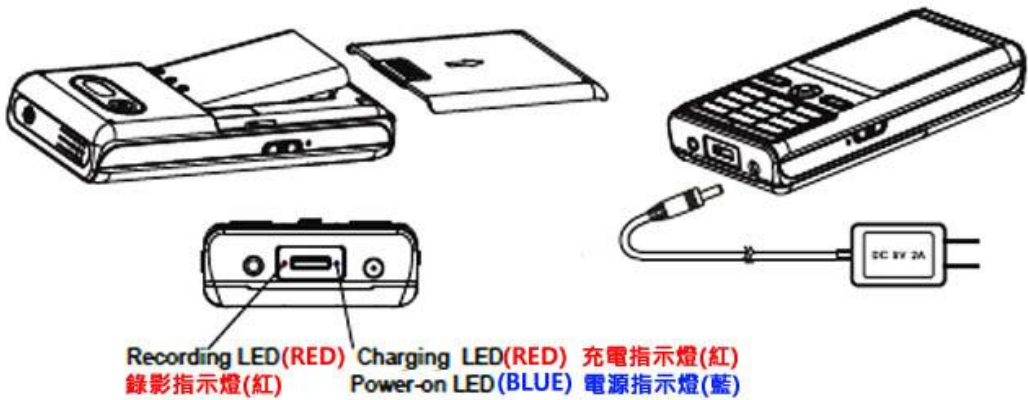

- 1) 充電時**紅燈**，充飽電時紅燈熄滅。
- 2) 開機狀態下充電為**藍燈**、**紅燈**皆亮。
- 3) 插電錄影(邊充邊錄)狀態下除**藍燈**、**紅燈**皆亮外，工作錄影指示燈處，亦亮**紅燈**。

●插入儲存媒介 Micro SD

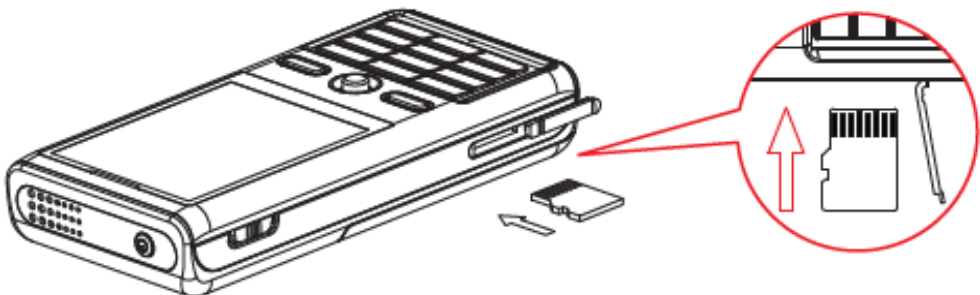

● 祕密蒐證模式

(A) 關閉 LCD：先按目錄鍵再按 * 字鍵

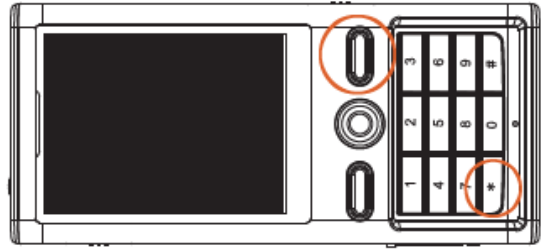

(B) 行動電話待機畫面：先按錄鍵再按 # 字鍵

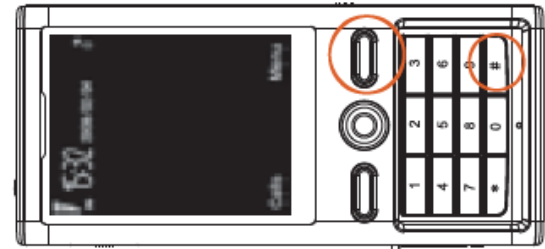
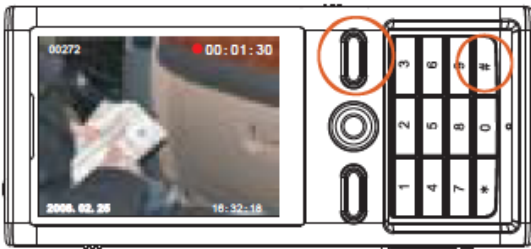

● 拍照

在任何錄影模式下，按數字鍵 **3**，螢幕上出現 **Capture** 則拍一張照片。



● **Illustration** 搭配參考圖(以實際出貨為準)

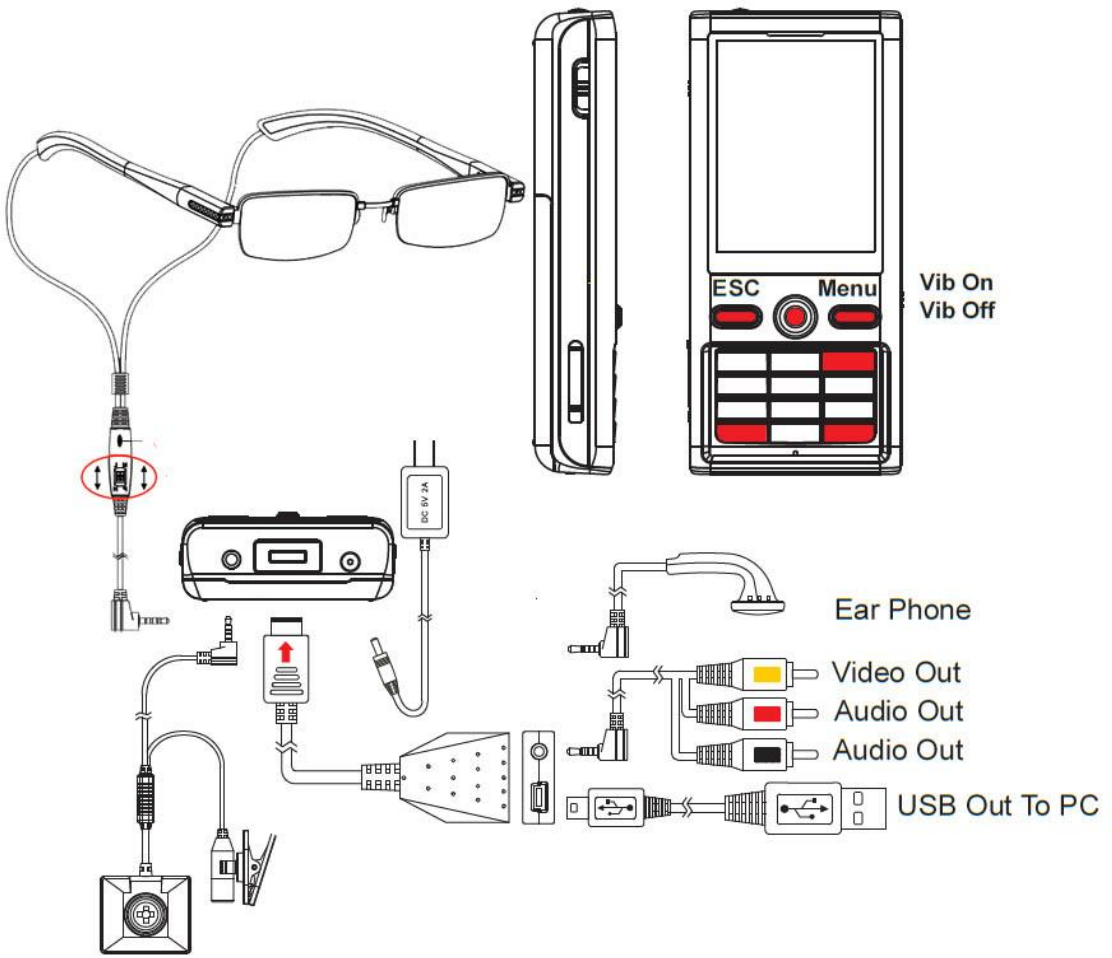

● 運用參考圖



●快速操作

[事前準備]

- 1)先設定好 **H28** 的時間(設定是否顯示時間戳記、張數戳印及本機序號)
- 2)設定解析度(包含畫質、張數、音效、覆蓋)
- 3)設定 **Spy Mode**[開啟]、**Spy Mode Duration**[10 秒]
- 4)設定背光關閉時間[30 秒]
- 5)回到主選單後，關機

產品說明



[錄影]

- 1)插入記憶卡，將指撥鍵撥到<錄影>，放入專用皮套內。
- 2)需要錄影蒐證時，按住電源鍵 **3** 秒，底部指示燈藍燈亮起，待 **5~10** 秒後，紅燈亮起，開始錄影。
- 3)結束時，長按電源鍵 **3** 鍵，自動存檔關機。

[產地] 台灣

[展示中心] 綠廣興業有限公司

[E-Mail] service@taiwan-spy.com

[地址] 台北市南港區忠孝東路六段 **388** 號

GL-H28 DIGITAL CAMERA Cellphone Design PVR

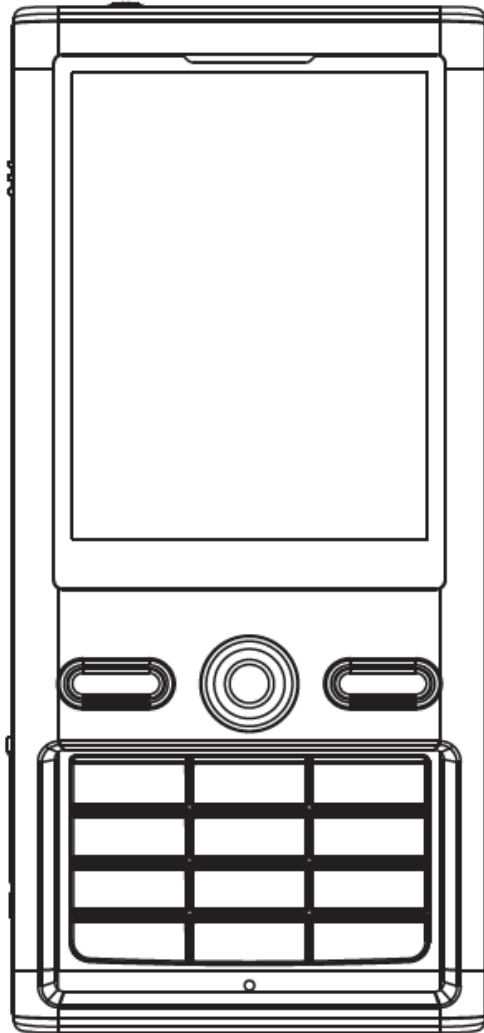

GREENLEAF ENTERPRISE
Professional SPY Products Manufacturer

●Name and Parts

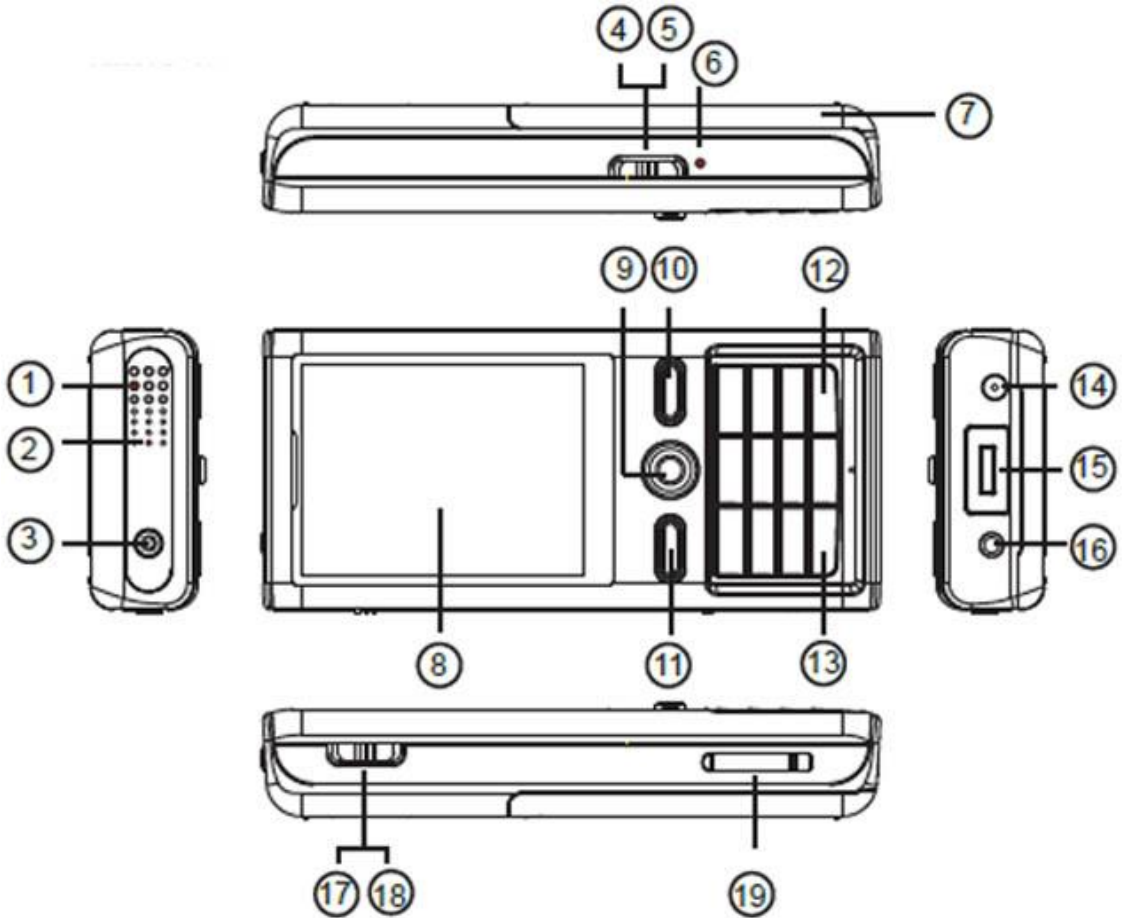

1.Digital Camera Lens	11.Escape Button
2.Microphone	12.Volume UP Button
3.Power Button	13.Volume DOWN Button
4.Vibration ON switch	14.DC Power Adapter Socket
5.Vibration OFF switch	15.Micro USB Port
6.Reset Button	16.AV Input Socket
7.Battery Tray	17.Stop Recording Switch
8. 2.5 LCD Display	18.Recording Switch
9.Navigation Key	19.Micro SD Slot
10.Menu Button	

● Package Content

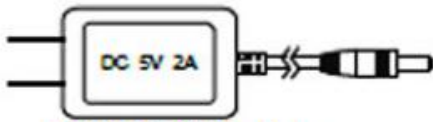

5V DC Adapter

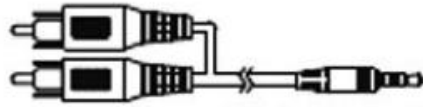

AV Out Cable 影音輸出線(2 prong)

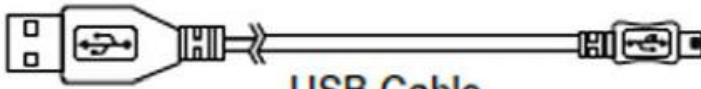

USB Cable



專用鋰電池
Li-ion Battery

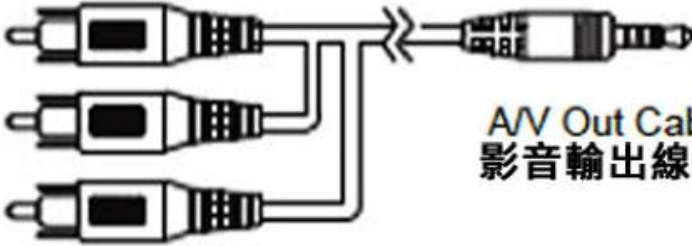

AV Out Cable
影音輸出線(3 prong)

● Charging Battery

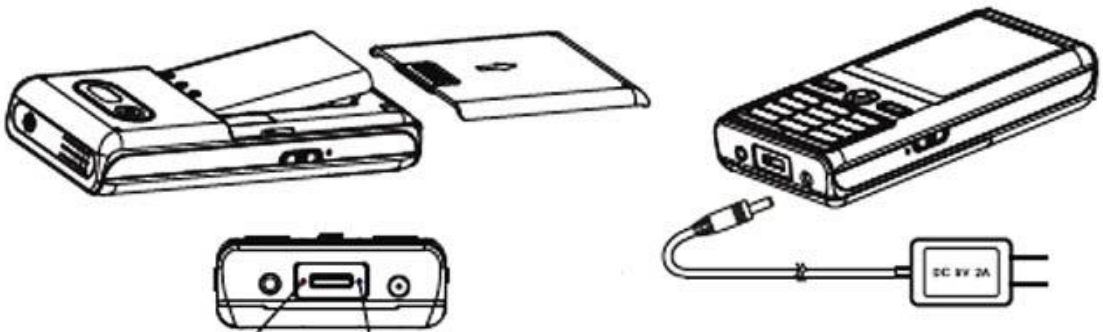

Recording LED (RED) 錄影指示燈 (紅)
Charging LED (RED) 充電指示燈 (紅)
Power-on LED (BLUE) 電源指示燈 (藍)

● Insert MicroSD Card

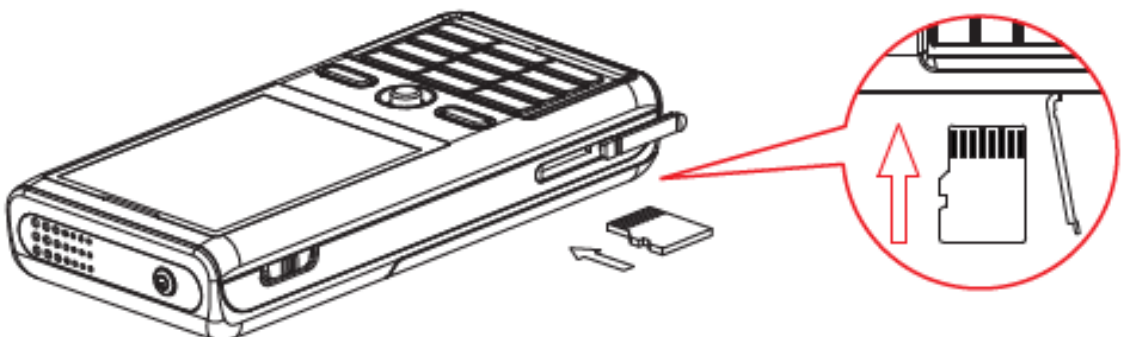

●Activate Spy Mode

(A)Screen-OFF Disguise Display

Press MENU + * button

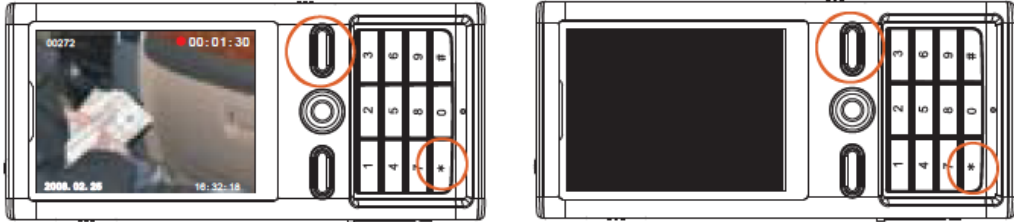

(A)Cellphone Power-ON Disguise Display

Press MENU + # button

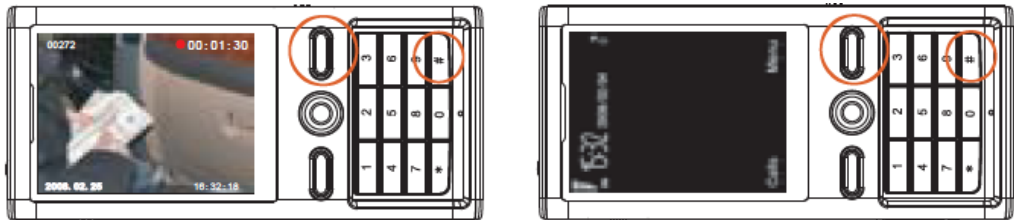

●Taking Snapshot

Record directly without disguise, go to Main>Record>Preview.

Captured images will be shown on screen.

Press 3 button to take snapshot.

● **Illustration** 搭配參考圖(以實際出貨為準)

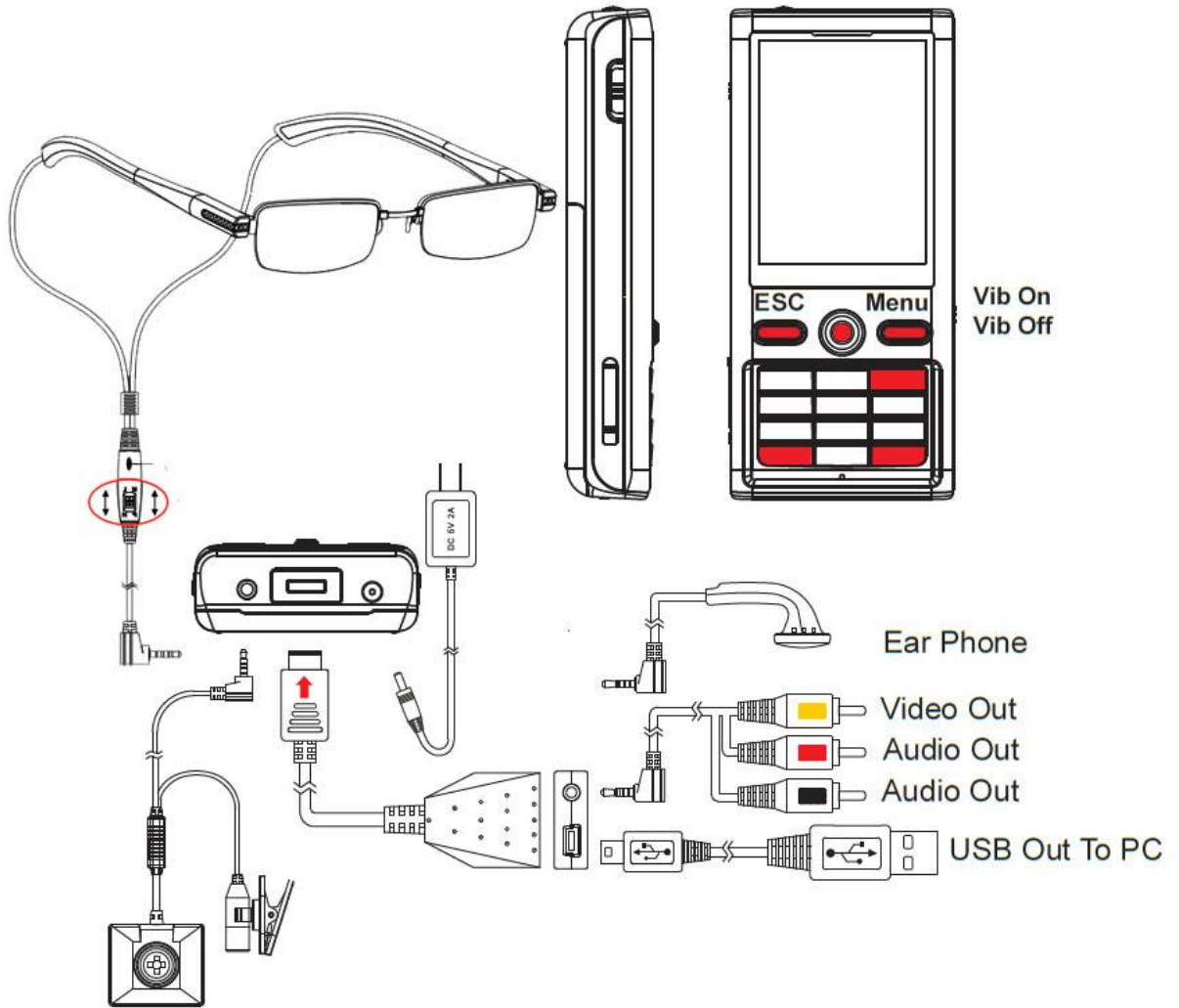

Made in TAIWAN

[Exhibition center] GREENLEAF Enterprise Co., Ltd.

[Address] No. 388, Chung-Hsiao E. Rd., Sec6, Taipei City, Taiwan, R.O.C.

[E-Mail] service@taiwan-spy.com